



Roll Over 5 Brushes Automatic Bus Washing Machine Blower Fixed KL-YK450 auto bus washer

Our Product Introduction

Basic Information

- Place of Origin: Shanghai, China
- Brand Name: KOLON
- Certification: CE
- Model Number: KL-YK450
- Minimum Order Quantity: 1 unit
- Price: USD28300
- Packaging Details: plywood case
- Delivery Time: 20 days
- Payment Terms: D/P, D/A, L/C, T/T, Western Union, MoneyGram
- Supply Ability: 1000unit per year



Product Specification

- Product Name: Roll-Over 5 Brushes Automatic Bus Washing Machine Blower Fixed KL-YK450
- Dimensions (length * Width * Height): 3.5*2.2*3M
- Foundation (length * Width * Height): *110*3.7*3.2M
- Material: Import Components, Hot-dip Galvanized Frame
- Application: Bus Body Cleaning, Bus Washer / Automatic Bus Washing Machine, Van, commercial Vehicle
- Function: Spray Foam, Clean By Foam And Air, Car Washer / Touchless Automatic Car Washing Machine
- Cleaning Speed: 2-3min/car
- Air Pressure: 2-5 BAR
- Wire Requirements: Three-phase Four Wire 18KW
Power Requirement: 380v/20.5KW



More Images



for more products please visit us on automaticcarwashing.com

Roll-Over 5 brushes Automatic Bus washing machine blower fixed

Model:[KL-YK450](#)

Dimension:

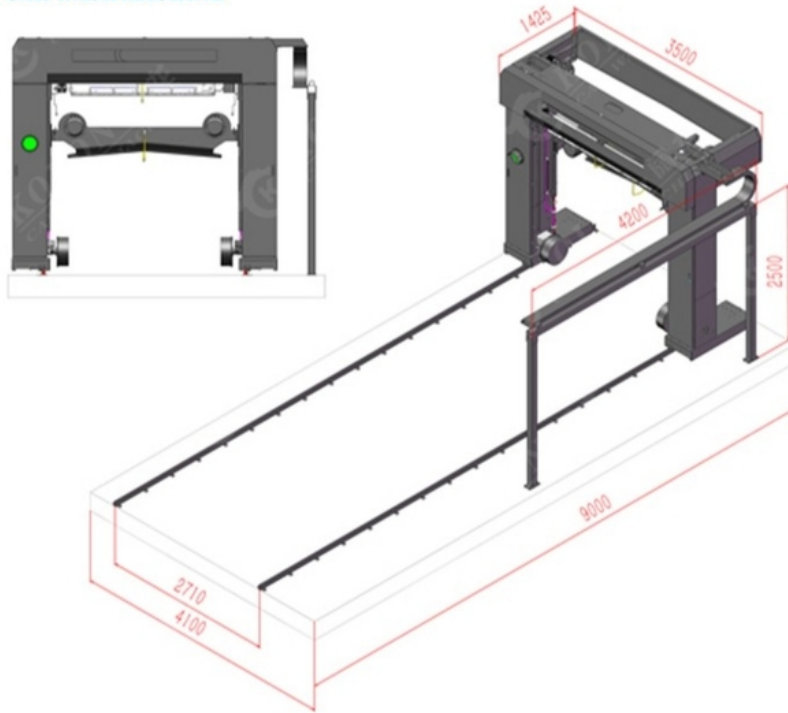

DG型 CAR WASH

Automatic Car Washing Machine Description :

The KL-YK450 auto car washer equipment features high-pressure water system and can clean deep stains to meet different customer requirements. This soft touch car wash machine utilizes soft brushes, which can quickly rotate and move in various directions to remove contaminations on the surface during operation.



Specification:

| | |
|---------------------------------------|---|
| Warranty | 3 years, man-made damage excluded |
| Machine Size | 3.5*2.2*2.9M(L*W*H) |
| Foundation Size: | 110*3.7*3.2M(L*W*H) |
| Site Requirements | Ground hardening |
| Proportioning machine size | integrating with the machine |
| Wire requirements | three-phase four wire 18KW |
| Air pressure | 2-5 BAR |
| Max washing height | 2800mm |
| Max washing width | 2200mm |
| Max washing length | 5500mm |
| Power needed | 380V/20.5KW |
| Running power | Air-dry power 12KW(4PCS*3KW) Siemens motor Cleaning working power:8.5kw |
| Water Consumption | 80-100L/car |
| Washing Time | 3-5mins/car |
| Power Consumption | 0.5-1kwh/car |
| Machine weight | 2400Kg/18.5CMB |
| Total Power | 380V/20.5KW |
| Washing liquid Consumption | 50ml/car |
| Water wax consumption | 50ml/car,Controllable |
| Applicable vehicle type | car,van,commercial vehicle |
| Water pressure requirements | 1.4-3kgs tap-water pressure; 6-minute diameter water pipe flow >40L/min |
| Rail | 2pcs (6m) |
| Framework | 1 set |
| Washing pressure | 30-50KG |
| Standard car wash mode | ● |
| Washing Quantity count | ● |
| Fine car Wash Mode | ● |
| Operation permission setting | ● |
| Fully automatic car wash mode | ● |
| Fault self-test function | ● |
| LED indicating system | ● |
| Mirror cleaning | ● |
| Automatic liquid proportioning system | ● |
| One click antifreeze system | ● |

| | |
|---|---|
| Chassis tire washing function | ● |
| Oil free function | ● |
| Intelligent three-dimensional detection system | ● |
| Multi liquid reuse function | ● |
| Self-guided parking system | ● |
| Safety alarm function | ● |
| Digital safety anti-collision system | ● |
| Automatic standby function | ● |
| 360 degrees rotary washing | ● |
| Hot dip galvanized frame | ● |
| Washing Detergent | ● |
| Operation console | ● |
| Highlight and dazzle color system (dazzle color type) | ● |
| Leakage protector | ● |
| Water wax coated function | ● |
| Warning system | ● |
| Magic Color Shampoo | ● |
| Voice warning system | ● |
| Built-in automatic air drying | ● |
| Soft water spray | ● |
| Controller | ● |
| Function Equipped | Chassis washing |
| | Wheel washing |
| | soft touch car wash machine with 5 brushes |
| | High precision low foam water wax 2-in-1 ratio function |
| | Powerful air drying |

Products Description:

Product Overview

Automatic foam spraying rollover car wash machine

The KL-YK450 car wash equipment features high-pressure water system and can clean deep stains to meet different customer requirements. This soft touch car wash machine utilizes soft brushes, which can quickly rotate and move in various directions to remove contamination on the surface during operation.

Details:

Air-dry power 12kw(4PCS * 3KW)Siemens motor

waterproof,dustproof and shakeproof motor and reducer is Siemens brand.It is very durable and energy saving.



rotary motor(galvanizing process,rustless)



moving moter



fixed type or move up and down air dryer options available

























Height limit and speed limit:



Height limit



speed limit

| Car Wash Process | | | | | | | | | | |
|---|--|--|--|--|--|--|--|---|--|---|
| | Step 1 | Step 2 | Step 3 | Step 4 | Step 5 | Step 6 | Step 7 | Step 8 | Step 9 | Time |
| Mode 1 |  Wipe-free foam |  High pressure water |  Wax |  Air dry | | | | | |  2.5-3.5min |
| Mode 2 |  Wipe-free foam |  High pressure water |  Normal foam |  High pressure water |  Wax |  Air dry | | | |  3.5-4.5min |
| Mode 3 |  Wipe-free foam |  High pressure water |  Normal foam |  High pressure water |  Water fall-foam |  High pressure water |  Wax |  Air dry | |  6-7min |
| Mode 4 |  High pressure water |  Wipe-free foam |  High pressure water |  Normal foam |  High pressure water |  Water fall-foam |  High pressure water |  Wax |  Air dry |  8-10min |
| Model 5..... | | | | | | | | | | |
| Model 6..... | | | | | | | | | | |
| You can include any activities in any mode as per your willing | | | | | | | | | | |

The brushes are gentle enough to protect the paint. It can completely wash the car with the use of automobile detergent. The brushes will rotate automatically to shake off the water and impurities at the end of washing.

Using a brush car washer can provide several benefits for your car's appearance and overall maintenance. Here are some key advantages:

Automatic Car Washing Machine Features :

The welding-free frame is made of hot dip galvanized steel which makes it quite durable and corrosion resistant.

The machine is with 5 brushes. 1 top brush, 2 side brushes and 2 wheel brushes that can wash the car completely.

This machine is equipped with 4 drying motors that can ensure drying effect.

The combination of automobile detergent and brush washing could remove the contamination on the surface more effectively. Hydrophobic Wax improves drying effect.

Detergent application: Specialized detergents are applied to help break down and remove tough stains and grime.

An automatic bus washing machine with roll-over brushes offers several advantages over other types of bus washing systems.

Here are five advantages of a roll-over brush automatic bus washing machine:

Efficient Cleaning: Roll-over brush machines are designed to provide thorough and efficient cleaning of buses. The rotating brushes effectively scrub the entire surface of the bus, removing dirt, grime, and road film.

Time-Saving: These machines are designed for quick and efficient cleaning, allowing buses to be cleaned in a relatively short amount of time. The automated process eliminates the need for manual scrubbing, saving labor and reducing cleaning time.

Consistent Cleaning Results: The automated system ensures consistent cleaning results for every bus that goes through the machine. The brushes are designed to apply consistent pressure and cleaning action, resulting in a uniform and high-quality cleaning finish.

Versatility: Roll-over brush machines are designed to accommodate different sizes and types of buses. They can handle various bus configurations, including low-floor buses, articulated buses, and double-decker buses. The adjustable brush pressure and positioning allow for effective cleaning of different bus designs.

Gentle on Surfaces: Despite their effective cleaning action, roll-over brush machines are designed to be gentle on the bus surfaces. The brushes are typically made of soft and durable materials that effectively clean without causing damage or scratches to the bus's exterior.

Overall, an automatic roll-over brush bus washing machine offers efficient, time-saving, and consistent cleaning results while being versatile and gentle on the bus surfaces. It is a reliable solution for keeping buses clean and maintaining their appearance.

Product packaging



FAQ

Q: Are your car wash machine trader or manufacturer?

A: Yes, we are the car wash machines manufacturer in china. Our brand is Kolonwash. So we have the competitive price, and could provide the spare parts at any time.

Q: What types car wash machines can you produce?

A: We can produce the rollover car wash machine, tunnel car wash machine, touchless car wash machine. Besides, could be customized according to your request.

Q: Can the color and appearance be customized?

A: Yes, of course, they could be customized, just tell me what color you need, and the drawing of the appearance, we could do according to your request.

Q: Can I put my brand name on machine instead of your brand name?

A: Yes, we could stick your brand name on the machines according to your request.

Q: What is the delivery time?

A: Our lead time is 10-15 days once get the advanced payment , according to which type you need.

Q: What about the foundation? How long will it take?

A: We could provide the drawing of the foundation, it needs around 5 days.

Q: How to install the machine? And how to do daily maintenance?

A: We could provide the installation drawing and guided installation video. We could provide the maintenance manual to you.

Q: How about the warranty time and sales-after service?

A: Our machine warranty time: 3 years (50000 times), in warranty time, if the machine have any question, we could provide the parts free of charge.

Q: How to contact you?

A:WhatsApp/Mb.:+86-18964350873 Email:zoe@koloncarwashing.com:+86-17765180874(WhatsApp,Wechat)
cici@koloncarwashing.com



Shanghai Kuolong Cleaning Machinery Co. Ltd.



+86-17765180874



cici@koloncarwashing.com



automaticcarwashing.com

1778 Huateng Road, Qingpu District, Shanghai, 201708,China